



Eagle Pilots Guide



Alpha Systems AOA

6180 140th Ave. N.W.

Ramsey, MN 55303

Customer Support

763.506.9990

aoa@depotstar.com

The information contained in this manual is for reference only. If any information contained herein conflicts with similar information contained in the Airplane Flight Manual, the information in the Airplane Flight Manual shall take precedence.

COPYRIGHT NOTICE

© 2016, Alpha Systems AOA. All rights reserved.

Eagle

PILOT'S GUIDE
P# AOA-9051-EAGLE

Revision History

Manual	Eagle Pilot's Guide
Rev	A - March, 2016
Summary	New release

Table of Contents

1. INTRODUCTION	1-1
1.1 Background Information:	1-1
1.2 System Description:	1-1
1.3 Restrictions and Limitations:	1-2
2. EAGLE CONTROLS	2-1
2.1 Display Controls	2-1
2.2 Switch Panel Controls:	2-2
2.3 Eagle Display Segments:	2-3
2.5 Stall Set-point Calibration:	2-5
2.6 Flap Calibration Set-points:	2-5
2.7 Setting Calibrated Day / Night Brightness Levels:	2-6
2.8 Adjusting the Audio Volume Level:	2-7
2.10 Select Audio Type:	2-8
2.11 Brightness Adjustment When Active:	2-9
2.12 In-flight Calibration Flow Chart:	2-9
3. OPERATION	3-1
3.1 Practice High AOA Flight Regime:	3-2
Observed Indications:	3-3
As the recovery progresses:	3-4
3.2 Practice Takeoff and Climb Using AOA:	3-7
Establish Segments Illuminated	3-8
Fly Practice Takeoffs for Familiarization	3-9
3.3 Practice Best Glide Speed:	3-11
Establish Segments Illuminated	3-11
3.4 Practice Approaches Using AOA:	3-13
Establish Segments Illuminated	3-14
Fly Practice Approaches for Familiarization	3-15
Useful Techniques when using the Eagle Indicator	3-16
NOTES	3-18
4. APPENDIX	4-1
4.1 Acronyms and Abbreviations:	4-1
TERMS	4-1
DEFINITIONS	4-1

List of Tables

Table 2-1: Eagle Display Control Features	2-1
Table 2-2: Switch Panel Controls	2-2
Table 2-3: Segment Conditions	2-3
Table 3-1: Observed Indications Chart	3-17

1. INTRODUCTION

1.1 Background Information:

The Alpha Systems AOA system was primarily designed to improve operational safety of airplanes by increasing pilot awareness of available lift during operations at high angles of attack. Additional benefits include identifying aircraft performance based on a fixed angle of attack or a constant CL, such as maximum range and best glide - Stall.

AOA: Angle of Attack is the difference between the airfoils chord line (a line from the leading edge to the trailing edge of the wing) and the relative wind (the inverse of the aircraft flight path).

CL: Coefficient of Lift is a relative measure of an airfoil's lifting capabilities.

CLmax: Coefficient of Lift Maximum is the angle of attack which if exceeded will cause the airfoil to stall.

CD: Coefficient of Drag is a measure of total drag; induced and parasite drag.

CL/CD: Coefficient of Lift over Coefficient of Drag is a ratio between lift and drag.

CL/CD Maximum: is the maximum lift-to-drag ratio at which maximum range and maximum glide distance will be found for propeller airplanes.

1.2 System Description:

The Alpha Systems AOA "Eagle," measures pressure at two points from an AOA probe mounted solidly to the wing in reference to the cord of the wing that conveys changing differential pressures, via sense lines, to the IF module. The IF module converts the pressures into an electronic signal that is transmitted to the Eagle indicator.

The Eagle indicator interprets the signal and turns on the appropriate segments to convey the AOA or lift information to the pilot. In addition to the visual display, the IF module also has an I/O connector that allows connection of the remote audio interface system that provides warning annunciations in the pilot's headset.

The Alpha Systems AOA system draws a minimal current of approximately $\frac{1}{4}$ Amp (250mA) of electrical power. For the system to operate correctly, it must be supplied electrical power within a range of 12 to 28VDC, be calibrated correctly and the openings on the AOA probe must be kept clear of any obstructions - mounted securely in clean air flow.

Probe heat is an option and if installed requires approximately 8 Amps of electrical power at 12 or 28VDC to operate. To extend the life of the probe's heating element, it is recommended that the probe heat not be used while on the ground.

1.3 Restrictions and Limitations:

The Alpha Systems AOA cannot be placed in the cockpit in such a manner as to interfere with the pilot's view of primary flight instruments.

The Alpha Systems AOA cannot be placed in the cockpit in such a manner as to obstruct the pilot's view or cause distraction.

The Alpha Systems AOA is a stand-alone system and does not replace any existing, primary instruments, or displays and is not considered essential for flight.

2. EAGLE CONTROLS

2.1 Display Controls

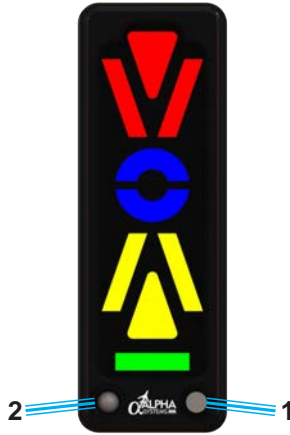

Figure 2-1 DSTR-AOA-9600 (L2.0 Display)_Straight_Lights_On.png Controls

Use the table below for a description of the functionality of the controls in Figure 2-1

Table 2-1: Eagle Display Control Features

ITEM	CONTROL	FUNCTION
1	Brightness Button	This button is at the bottom right of the Eagle display and when pressed repeatedly, will step through 16 levels of brightness. When the maximum brightness level is reached, the brightness returns to the minimum and steps up each time the button is pressed again.
2	Auto Brightness Photocell	The photo cell is at the lower left of the AOA display automatically detects the ambient light and will switch from “day time” brightness preset to “night time” brightness presets automatically. The Brightness push button can override either preset at any time.

2.2 Switch Panel Controls:

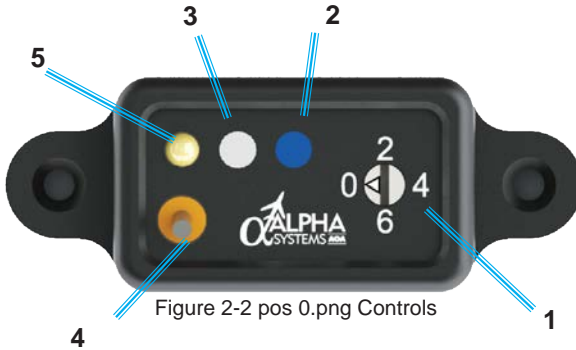



Table 2-2: Switch Panel Controls

ITEM	CONTROL	FUNCTION
1	Rotary Switch	Is an 8 position rotary switch that has a TRIANGLE SHAPED POINTER to indicate the switch position, NOT THE SCREW DRIVER SLOT. There are markings on the case at 0, 2, 4, 6 but can be positioned in-between to gain access to the odd numbered modes when directed in the calibration procedure.
2	CAL Button	This button is the recessed blue button and is marked "CAL". This button is used to enter various calibration values (OAA & Cruise) during the calibration procedures.
3	SEL Button	This button is used to enter the calibration modes when the rotary switch is in the corresponding mode set position.
4	Audio Mute Switch	This switch mutes the audio warning when in the UP position.
5	Audio Mute LED	This amber led illuminates when the audio alarm has been deactivated by the audio mute switch.







2.3 Eagle Display Segments:







Nine segments on the display are color coded and will transition and illuminate with additional available lift from **Red triangle**  in a sequence to the **Green bar**  and once calibrated (in accordance with the Eagle Operations Manual AOA-9610), to the angle of attack to the specific aircraft.

A correctly calibrated Eagle will provide a linear increase in AOA indication as the aircraft slows. The final stall indications **MUST** be active prior to the actual aerodynamic stall. Ensure during post-calibration testing that the final Eagle alert state is displayed prior to any stall indications.

The entire slow flight range of no lift to Cruise will allow for a possibility of 14 combinations of colored segments in the following order (Table 2-3):

Table 2-3: Segment Conditions

SEGMENT	ABBR	CONDITIONS
	G	Green Bar with no other segments indicates Cruise set point, (lots of lift).
	YG	Green Bar & Yellow Triangle with no other segments indicates slowing/moderate AOA.
	YT	Yellow Triangle with no other segments indicates pattern entry/increasing AOA.
	Y1	Yellow Triangle & Chevrons with no other segments indicates pattern entry/increasing AOA.
	Y2	Yellow Chevrons with no other segments indicates Base leg/increasing AOA.
	YB	Yellow Chevrons & Lower Blue Doughnut indicates Final/slightly fast.
	B1	Lower Blue Doughnut indicates Final/slightly fast.

	BD	Complete Blue Doughnut with no other segments indicates Optimum Alpha Angle (OAA).
	B2	Upper Blue Doughnut with no other segments indicates slightly slow/below OAA.
	BR	Upper Blue Doughnut & Red Chevrons with no other segments indicates slightly slow/below OAA.
	R1	Red Chevrons with no other segments indicates too slow (level 1).
	R2	Red Chevrons & Triangle with no other segments indicates too slow (level 2) and system will announce calibrated stall warning.
	RT	Red Triangle with no other segments indicates critical AOA (level 3) and system will continue to announce calibrated stall warning.

Note: No segments illuminated = Power off, no pressure to I/F Module or aircraft on the ground.

2.5 Stall Set-point Calibration:

Stall set-points have been added to the clean OAA and Cruise set-point calibration procedure at rotary switch position 2.

If desired, a clean Stall set-point can be set by pressing the SEL button after the Cruise set-point has been set, instead of turning the Rotary Switch to position 0.

The system will announce "Set Stall Set-point."

To set the Stall set-point, press the CAL button when at the appropriate flight pattern. The system will save the set-point and announce "Stall Set-point Complete."

When done setting the Stall set-point, turn the Rotary Switch to position 0 and press the SEL button. The system will announce "Calibration Off."

Note: The system has been set up so that the user can set one, two, or all three Flap OAA Set-points and one, two, or three Flap Stall Set-points. This can be done by rotating the Rotary Switch to position 0 after the Flap Set-point has been set and pressing the SEL button. The system will announce "Calibration Off" after setting the desired set- points.

2.7 Setting Calibrated Day / Night Brightness Levels:

Note: There are 16 levels of brightness from a minimum level to a maximum level.

The Eagle is preset at the factory for daytime/nighttime brightness levels. If the maximum/minimum brightness levels need to be changed in your aircraft, do the following procedure to preset both the daytime and nighttime display brightness levels while on the ground.

1. With power OFF, turn the Rotary Switch to position 3.
2. Hold the SEL button down and power the AOA ON.
3. The unit will announce "Set Brightness Levels" and all LED segments will be illuminated.
4. Cover the photocell on the AOA DISPLAY with your thumb and wait 5 seconds.

With the photocell covered:

5. Press the brightness button repeatedly on the AOA DISPLAY until at the acceptable low ambient light brightness level.
6. Wait about 5 seconds for the unit to store the calibrated setting before removing your thumb.
7. Now, apply light directly to the photo diode on the AOA DISPLAY and wait 5 seconds.

With light on the photocell:

Press the brightness button repeatedly on the AOA DISPLAY until it is at the acceptable high ambient light brightness level.

You'll know when at the maximum brightness level because the unit will announce "Reached Maximum Brightness", and going passed it will cause the brightness of the LED segments to return to the minimum level.

- 8.) Wait about 5 seconds for the unit to store the calibrated setting before removing the light from the photocell.
- 9.) Power the system OFF.

2.8 Adjusting the Audio Volume Level:

1. With power OFF, turn the Rotary Switch to position 4.
2. Hold the SEL button down and power the unit on.
3. Wait until the unit announces "Set Volume."
4. Now, press the CAL button repeatedly until the acceptable volume level.

Note: When at the maximum volume level, the unit will announce "Maximum Volume Reached." When at the minimum volume level, the unit will announce "Minimum Volume Reached."

5. Power the unit OFF.

2.10 Select Audio Type:

1. With power OFF, turn the Rotary Switch to position 5.
2. Hold the SEL button down, power the unit on. The unit will announce "Set Audio Choice."

Currently there are 5 choices of audio:

A 3 beep audio tone when the AOA increases and the yellow chevron and only half of the blue doughnut are illuminated (audio occurs once) or,

A 2 note, high / low audio tone when the AOA and when the yellow chevron and only half of the blue doughnut are illuminated (audio occurs once) or,

A 2 note, high / low audio tone when the AOA increases and when the yellow chevron and only half of the blue doughnut are illuminated (audio occurs once) and a feminine voice "Too Slow" annunciation when the red chevrons and triangle are illuminated (repeats 3 times) or,

A feminine voice "Getting Slow" (audio occurs once) when the yellow chevron and only half of the blue doughnut are illuminated and a feminine voice "Too Slow" annunciation when the red chevrons and triangle are illuminated (repeats 3 times).

A doorbell tone occurs at the yellow chevron and first half of the blue doughnut. Then a "Slowing" annunciation occurs at the red chevrons and triangle indication.

3. Press and then release the CAL button.
4. If you want to select the next audio choice, press the CAL button again.
5. To select the 3rd audio choice, press the CAL button again.
6. To select the 4th audio choice, press the CAL button again.

Repeat until a desired audio choice is found. At that time, turn power OFF to the system and that selection will be stored to memory.

2.11 Brightness Adjustment When Active:

To change brightness when the unit is active, quickly push and release the Brightness button until the desired brightness level is reached.

There are 16 brightness levels and a photo cell to detect “nighttime” and “daytime” ambient light levels and automatically switches to the stored level.

2.12 In-flight Calibration Flow Chart:

The following flow charts contain an abbreviated version of the in-flight calibration procedures. The complete in-flight calibration procedures can be found in the Eagle Operations Manual, p/n AOA-9610.

It is highly recommended, to make calibration easier and safer, that the pilot flies the aircraft while a second person follows the calibration procedure and enters the appropriate set points for the instrument.

CAUTION

At ALL times, the Pilot-in-Command must fly the aircraft in a safe manner at altitude while maneuvering the aircraft in slow flight.

2.13 Calibrating Flap OAA Set-Points:

Once the system has been successfully calibrated in the “CLEAN” configuration of BOTH OAA and the CRUISE values, and STORING both values, the software will allow calibration of up to 3 additional OAA flap calibrations.

The flap OAA calibration process is identical to the clean configuration, fly or identify the weight adjusted stall speed for each wing configuration, Flap1, Flap2, Flap3, multiply each times 1.3.

Go to switch position 7 and press the SEL button to enter flap calibration. The unit will announce, “Flap Calibration ON, Set Flap 1”.

After entering the flap calibration routine, perform the flight maneuvers for OAA and press the CAL button.

Press the SEL button to enter the next flap set-point.

Go to switch position 0 and press SEL at any point to SAVE & EXIT the calibration routine.

STEP 1 IN-FLIGHT CALIBRATION OF EAGLE OPTIMUM ALPHA ANGLE (OAA) SET-POINT

Turn the Rotary Switch to position 2 (STEP A). Hold the SEL button and turn power ON (STEP B). The Blue Doughnut will flash three time and the unit will announce "Set-Point Calibration ON" "Set OAA Set-point". The system has entered the OAA set-point calibration mode.

Note: The Blue Doughnut will quickly flash every 5 to 6 seconds, indicating that the system is still in OAA calibration mode.

To set an OAA, press and release the CAL button (STEP C).

Good OAA Set-point?

SET AGAIN?

GOOD

Once a good OAA Set point has been achieved, the pilot continues to STEP 2 and MUST enter into the Cruise Calibration Mode or repeat the OAA Set point Operation.

In-Flight calibration requires the pilot to climb to a safe altitude for slow flight maneuvers. The pilot will fly the aircraft to the condition of Optimum Alpha Angle (OAA). Aircraft is at OAA, when:

1. Aircraft is at a safe altitude for slow flight maneuvers.
2. Minimum controllable flight, lower power setting (such as a down wind or landing pattern power setting).
3. Able to hold altitude, 0 Vertical Speed, **not descending, zero sink (5 to 10 fpm climb OK if your aircraft loses flight control stability at 0 VS).**
4. Full aileron, elevator and rudder control, not in a buffet, pilot to identify the set point by pitching back slowly to a pitch no longer able to climb but able to hold altitude with full control of the airplane.



Figure 2-3 DSTR-AOA-9600 (L2.0 Display)_Straight_Lights_On.png Controls

BAD

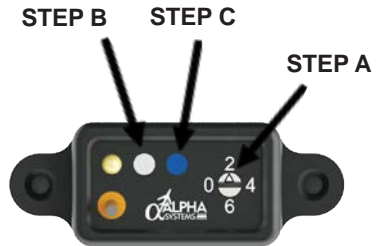

Figure 2-4 pos 2.png Controls

STEP 2 IN-FLIGHT CALIBRATION OF EAGLE CRUISE SET-POINT

Leave the Rotary Switch in position 2 and press the SEL (white) button (STEP A). The Green Bar LED will flash and the system will announce, "Set Cruise Set-point". The system has entered Cruise set-point calibration mode.

Note: The Green Bar will quickly flash every 5 to 6 seconds, indicating that the system is still in Cruise calibration mode.

The pilot must fly the aircraft at a "Cruise" In-flight condition, straight and level, holding altitude at Cruise power. This procedure sets the display to indicate "Cruise" AOA for the aircraft.



Figure 2-5 DSTR-AOA-9600 (L2.0 Display)_Straight_Lights_On.png Controls

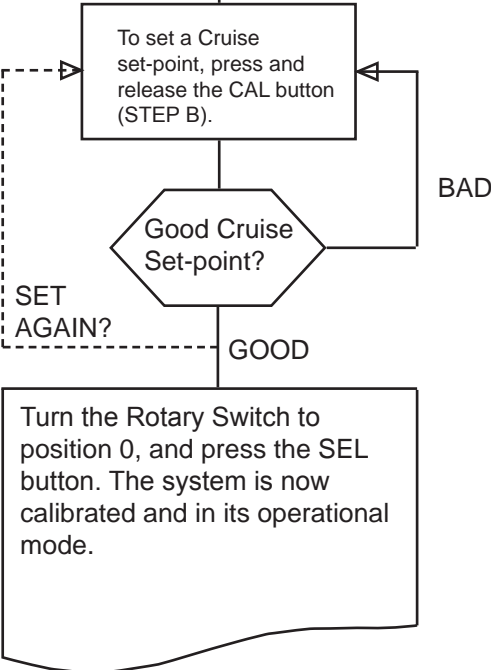

Figure 2-6 pos 2.png Controls

(PAGE INTENTIONALLY LEFT BLANK)

3. OPERATION

The Alpha Systems AOA Eagle improves pilot awareness of available lift during operation at high angles of attack such as slow flight, takeoffs and landings.

The system is calibrated with the aircraft in the clean configuration. When flaps are extended, the Eagle AOA indications will be more conservative (View the Flap IO Extension Kit information in your Installation Manual).

This section explains the procedures to be flown to develop a reference list that shows the segments that are lit on the Eagle Indicator during the different phases of flight.

Section 3.1 on page 3-2 gives the procedure to practice a high AOA flight regime with the use of the Eagle Indicator.

Section 3.2 on page 3-7 gives the procedures to practice takeoffs and climb outs with the use of the Eagle Indicator.

Section 3.3 on page 3-11 gives the procedures to maintain best glide speed with the use of the Eagle Indicator.

Section 3.4 on page 3-13 gives the procedures to practice approaches with the use of the Eagle Indicator.





3.1 Practice High AOA Flight Regime:

To familiarize you with the Eagle indications during a high AOA flight regime, use the following outline as a guide:

- Plan a flight to an area where high AOA flight can be performed without any undue hazards (reference § 91.303 & § 91.305).
- Review the stall recovery procedures for your aircraft. If an inadvertent stall occurs, immediately recover from the stall per your training and the aircraft manufacturers instructions. At no time is a stall required to correctly calibrate or operate the Eagle.
- Acquaint yourself with the Eagle indicator and its functions.
- Preflight and operate the aircraft as you would normally.
- When in an area and at a safe altitude that safe operation at slow flight can be performed and the air is smooth, perform clearing turns to ensure the area is clear.
- Follow the aircraft procedures and slow the aircraft, in the clean configuration (No Flaps).
- Maintain coordination.
- Maintain altitude.
- Monitor the Eagle indicator.
- Slow to just above the stall. If any stall warning device activates or an impending aerodynamic stall is imminent, recover immediately using the appropriate procedure for your aircraft.
- Return to normal flight.
- Using the abbreviations from Table 2-2 on page 2-3 & 4, write down the illuminated segments in the space provided below and in the Table 3-1: Observed Indications Chart on page 3-17.

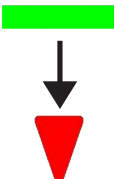
Observed Indications:



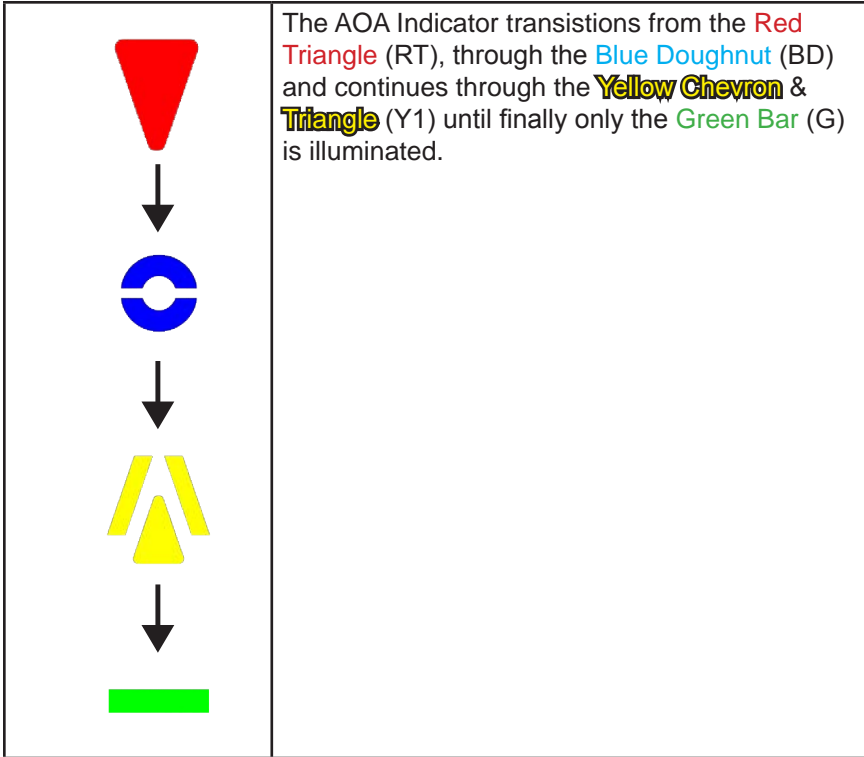

As the aircraft slows and the AOA increases, note the following:

	<p>The colored segments on the AOA indicator transitions from the Green Bar (G) segment (Cruise) up through to the Red Traingle (RT) segment.</p>
	<p>The selected audio warning will sound as the AOA increases and the Yellow Chevrons and first part of the Blue Doughnut (YB) are illuminated.</p>
	<p>The stall warning of the selected audio choice will sound as the AOA continues to increase and the Red Chevrons and Triangle (R2) are illuminated.</p>
	<p>Start your recovery from the high AOA flight regime when only the Red Triangle (RT) is illuminated.</p> <p><i>Note: If any stall warning device activates or an impending aerodynamic stall is imminent, recover immediately using the appropriate procedure for your aircraft.</i></p>

As the recovery progresses:

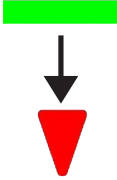

Follow the outline on page 3-2 again, but perform the high AOA flight regime in the landing configuration (dirty) and observe the following:

	<p>The colored segments on the AOA indicator transitions from the Green Bar (G) segment (Cruise) up through to the Red Triangle (RT) segment.</p>
	<p>The selected audio warning will sound as the AOA increases and the Yellow Chevrons and first part of the Blue Doughnut (YB) are illuminated.</p>
	<p>The stall warning of the selected audio choice will sound as the AOA continues to increase and the Red Chevrons and Triangle (R2) are illuminated.</p>
	<p>Start your recovery from the high AOA flight regime when only the Red Triangle (RT) is illuminated.</p> <p><i>Note: If any stall warning device activates or an impending aerodynamic stall is imminent, recover immediately using the appropriate procedure for your aircraft.</i></p>

In general, the indications translate to:

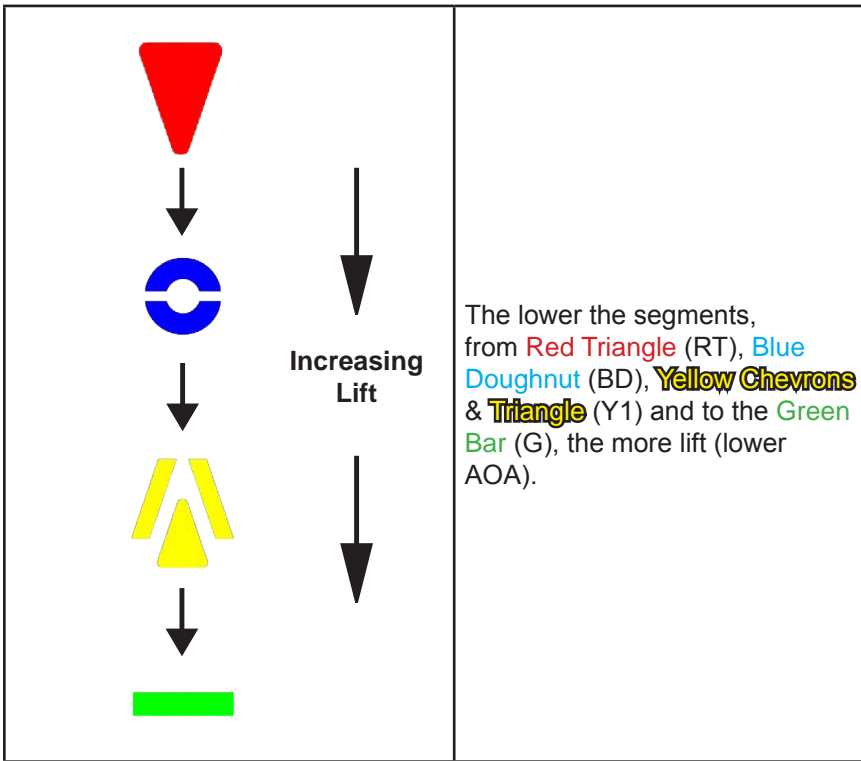

Practice until you become familiar with the indications on the AOA and the relationship of your airspeed indicator. Since the airfoil on your aircraft will ALWAYS stall at the same AOA (regardless of weight) the AOA indications will be the same every time.

3.2 Practice Takeoff and Climb Using AOA:

The use of AOA for takeoff and climb performance will greatly increase the pilot's awareness while operating at high angles of attack and yield safe and consistent results.

For example, if you intend to perform a short field over an obstacle takeoff there are a number of factors you must consider to arrive at the proper indicated airspeed for the climb. Changing gross weight, pressure, altitude and temperature will all have an effect on the indicated climb speed. On the other hand, once you establish the correct AOA for the climb, it will be the same regardless of the factors previously mentioned.

To determine the correct AOA for a climb we need a baseline to start from. For this example we will figure it out for V_x (best angle of climb). Some aircraft may use two different speeds based on the aircraft configuration, let's use the one for clearing an obstacle on takeoff. Refer to the aircraft manual to determine the configuration and airspeed for V_x considering the following factors:

- Identify actual gross weight.
- Pressure altitude, at the demonstration altitude.
- Temperature, at the demonstration altitude.
- Correct Calibrated Air Speed (CAS) for installation errors to arrive at Indicated Air Speed (IAS).

Utilizing the flap input connections via the DSTR-AOA-1970 IO Module, available as an expansion kit, the display indications will change when you activate the takeoff flap position. With this, the display will provide a more accurate reading throughout all patterns of flight.

Establish Segments Illuminated

As before, to familiarize you with the Eagle indications for V_x use the following outline as a guide:

- Plan a flight to an area where the desired maneuvers may be performed without any undue hazards.
- Acquaint yourself with the Eagle indicator.
- Preflight and operate the aircraft as you would normally.
- When in the area, perform clearing turns to ensure the area is clear.
- Maintain coordination and altitude.
- Use power to slow and configure for V_x .
- Maintain the indicated airspeed for V_x .
- Observe the Eagle AOA indication and make a mental note.
- Return to normal flight.
- Using the abbreviations from Table 2-2 on page 2-4, write down the illuminated segments in the space provided below and in the Table 3-1: Observed Indications Chart on page 3-17.

The following indications are accurate for future use at any gross weight or altitude, every time. Also, this same method may be used to determine the AOA for any climb. Now try it for V_y , best rate of climb, using the procedure described above.

Segments Illuminated:

Fly Practice Takeoffs for Familiarization

Now practice the use of the AOA for takeoff at airports that give you a comfortable margin. Then when you perfect the technique you can perform short field over an obstacle takeoffs safely. Use the following outline as a guide:

- Review your aircraft procedures for short field over an obstacle takeoff.
- Plan for a flight at an airport where normal takeoffs and landing may be performed.
- Preflight and operate the aircraft as you would normally.
- Perform the takeoff run as specified in the aircraft manual.
- At the specified takeoff speed, rotate smoothly to the AOA for V_x .

CAUTION

Do not over-rotate or rotate too rapidly as either will cause catastrophic results.

- When well above the obstacle, decrease the AOA and clean up on schedule.
- Adjust the pitch to achieve the AOA for V_y and continue the climb.
- Return to normal flight.
- Using the abbreviations from Table 2-2 on page 2-4, write down the illuminated segments in the space provided below and in the Table 3-1: Observed Indications Chart on page 3- 17.

Segments Illuminated:

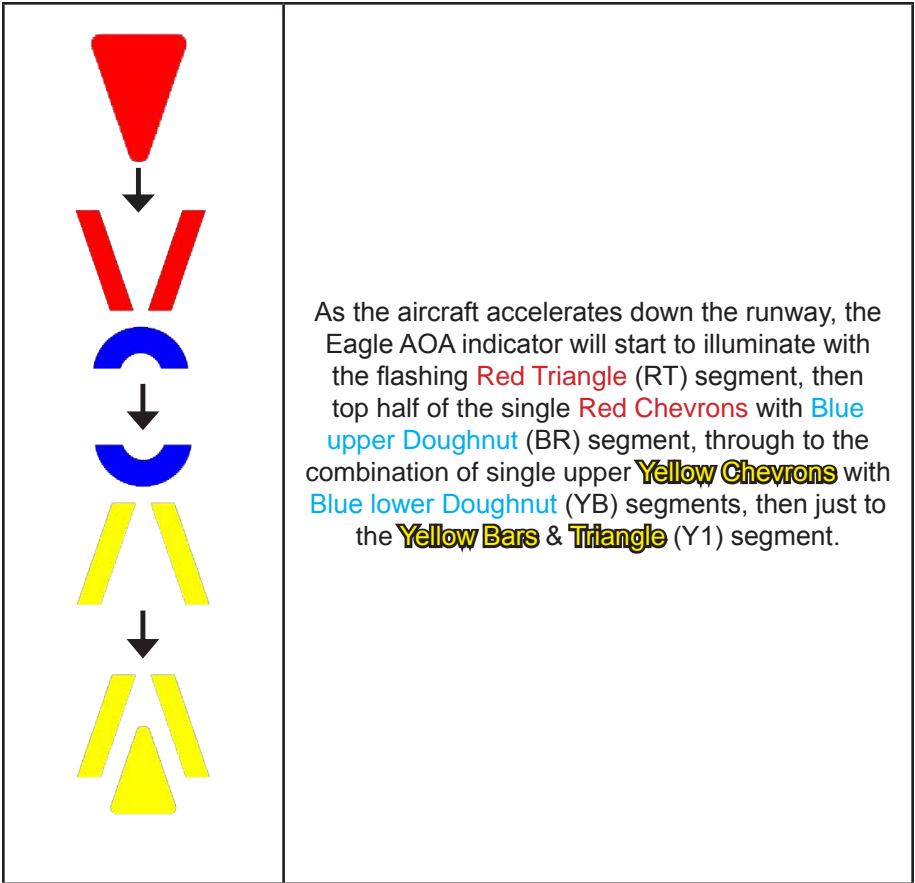

3.3 Practice Best Glide Speed:

As mentioned earlier, the AOA may be used for identifying aircraft performance based on a fixed AOA or a constant CL. For this discussion CL/CD Maximum indication will be identified. This is the maximum lift-to-drag ratio at which maximum range and maximum glide distance will be found for propeller airplanes.

To find the AOA for best glide, calculate an indicated airspeed considering:

- Actual gross weight.
- Pressure altitude, at the demonstration altitude.
- Temperature, at the demonstration altitude.
- Correct CAS for installation errors to arrive at IAS.

Establish Segments Illuminated

As before, to familiarize you with the Eagle AOA indications for CL/CD Maximum, use the following outline as a guide:

- Plan a flight to an area where the desired maneuvers may be performed without any undue hazards.
- Acquaint yourself with the Eagle display AOA Indicator.
- Preflight and operate the aircraft as you would normally.
- When in the area, perform clearing turns to ensure the area is clear.
- Maintain coordination.
- Maintain altitude.
- Use power to slow and maintain best glide speed.
- Observe the Eagle display AOA indication; this is CL/CD Maximum.
- Return to normal flight.
- Using the abbreviations from Table 2-2 on page 2-4, write down the illuminated segments in the space provided below and in the Table 3-1: Observed indications chart on page 3-17.

The following indications will be correct for future use at any gross weight and/or altitude, every time. Document the angles of attack by the segments illuminated in a permanent record for future use.

Example: Best Glide  = single upper **Yellow Chevrons** with lower **Blue Doughnut** (YB).

Segments Illuminated:

3.4 Practice Approaches Using AOA:

A rule of thumb is to use an approach speed of 1.3 times the power off stall speed in the landing configuration. Another rule of thumb is in gusty winds add 5kts for one passenger and if it's really gusty add 10kts for several passengers. While flying the approach at higher speeds seems to be safer, having additional speed and kinetic energy on a short runway may not be in the best interest of said passengers. With the means to accurately know and control the AOA you can fly a more stable approach and land with less kinetic energy for any given situation than flying arbitrary approach speeds. Flying an approach and landing using an AOA indicator may be a safer procedure.

The AOA has been calibrated for an AOA just slightly less than CL_{MAX} ; however an acceptable margin above that angle to fly approach and landings has not been determined. As a starting point, use the aircraft manual to determine the stall speed of the aircraft at the actual gross weight in the landing configuration. Take that calibrated airspeed and multiply it by 1.3, 1.2 and 1.1. Then refer to the airspeed correction chart to determine the correction, if any, to convert from calibrated airspeed to indicated airspeed for the three speeds. For example:

Calibrated Stall Speed X 1.3 = App. CAS ± the correction = App. IAS
58 kts CAS X 1.3 = 75.4 kts CAS + 2 kts correction = 77 kts IAS

58 kts CAS X 1.2 = 69.6 kts CAS + 3 kts correction = 73 kts IAS
58 kts CAS X 1.1 = 63.8 kts CAS + 4 kts correction = 68 kts IAS

For ease of discussion, let's call these speeds and the resulting AOA indication as 3, 2 and 1 respectively. Once the AOA angles have been identified, they will be accurate at any gross weight, every time.

Utilizing the flap input connections via the DSTR-AOA-1970 IO Module, available as an expansion kit, the display indications will change when you activate the landing flap position. With this, the display will provide a more accurate reading throughout all patterns of flight.

Establish Segments Illuminated

To establish the AOA indications for approaches, use the following outline as a guide:

- Plan a flight to an area where approaches and slow flight can be performed without any undue hazards (reference § 91.303 & § 91.305).
- Review the stall recovery procedures for you aircraft in case of an inadvertent stall. If an inadvertent stall occurs, immediately recover from the stall per your training and the aircraft manufacturer's instructions. At no time is a stall required to correctly calibrate or operate the Eagle.
- Acquaint yourself with the Eagle display AOA indicator.
- Preflight and operate the aircraft as you would normally.
- When in an area where approaches and slow flight can be performed and the air is smooth, perform clearing turns to ensure the area is clear.
- Follow the aircraft procedures, slow and configure to the landing configuration.
- Maintain coordination.
- Maintain altitude with the pitch (use pitch trim to relieve back pressure).
- Use power as needed to maintain flight at the first of the calculated approach speeds, "3".
- Write down the colored segments illuminated. _____
- Use power as needed to slow to and maintain flight at the second of the calculated approach speeds, "2".
- Write the new segments illuminated. _____
- Use power as needed to slow to and maintain flight at the third of the calculated approach speeds, "1".
- Return to normal flight.
- Write the new segments illuminated. _____
- Write the segments illuminated for the 3 approaches in the Table 3-1: Observed Indications Chart on page 3-17.

Fly Practice Approaches for Familiarization

To familiarize you with the aircraft while flying practice approaches using the Eagle Indicator as a guide, please use the following outline:

- Plan a flight to an area where approaches and slow flight can be performed without any undue hazards (reference § 91.303 & § 91.305).
- Review the stall recovery procedures for your aircraft.
- Acquaint yourself with the Eagle indicator.
- Preflight and operate the aircraft as you would normally.
- When in an area where approaches and slow flight can be performed and the air is smooth, perform clearing turns to ensure the area is clear.
- Follow the aircraft procedures, slow and configure to the landing configuration.
- Maintain coordination.
- Set the power as you would to fly a normal approach.
- Maintain altitude with the pitch until the AOA approaches the “3” indication. Lower and use pitch to maintain that AOA (use pitch trim to relieve back pressure).
- Fly the aircraft in the descent (straight & turning), pay attention to the flight control effectiveness.
- Perform a recovery from the high AOA condition prior to any aerodynamic or aural/visual stall warning using the manufacturer's instructions for your aircraft.
- Climb back to the initial altitude.

Repeat the steps above using AOA indications “2” and “1”. Gain experience by practicing these simulated approaches and landings using the AOA indicator.

Some notable observations:

- The control effectiveness decreases with higher AOA.
- The higher the AOA, the more attention has to be given to rudder inputs to compensate for adverse yaw.
- Approaches at the higher angles of attack leaves little time between starting the flair and stall.

Useful Techniques when using Eagle Indicator

Some techniques and things to consider when using the Eagle Indicator to fly approaches are:

- Coordinate the use of pitch and power to fly the approach and landing.
- Use PITCH primarily to control the AOA.
- Use POWER primarily to control the descent rate.
- Keep in mind how much power it took to just maintain altitude.
- A stable approach all the way to the runway is much safer than making radical changes to the AOA or descent rate once an obstacle is cleared.
- Set a safe standard for yourself using all your experience to set a maximum AOA for any approach and do not let pressures cause you to fly an approach at too high of AOA.
- When flying in gusty conditions fly a lower AOA so that when a wind gust changes your AOA it does not exceed your maximum AOA.
- Having a great new system to indicate AOA does NOT change the laws of physics, use it as a new tool to fly safe.

Write down the actual indications you observe on the Eagle Indicator as you conduct the different phases of flight.













SEGMENT	ABBR	Phase of Flight	Flaps Up (Clean)	Flaps Down (Dirty)
	G	High AOA (pre-stall)		
	YG	Climb Vx		
	YT	Climb Vy		
	Y1	Cruise		
	Y2	Best Glide Speed		
	YB	Approaches		
	B1	1.3 Vs		
	BD	1.2 Vs		
	B2	1.1 Vs		
	BR			
	R1			
	R2			
	RT			

Table 3-1: Observed Indications Chart

NOTES

4. APPENDIX

4.1 Acronyms and Abbreviations:

Acronyms and abbreviations used in this manual are defined as follows:

TERMS	DEFINITIONS
AOA	Angle of Attack
CAS	Calibrated Air Speed
CL	Coefficient of Lift
CLMAX	Coefficient of Lift Maximum
CD	Coefficient of Drag
CL/CD	Coefficient of Lift over Coefficient of Drag
FAA	Federal Aviation Administration
IF Module	Interface Module
IA	Inspection Authorization
IAS	Indicated Air Speed
kts	Nautical miles per hour
MAV	Mean Aerodynamic Chord
OAA	Optimum Alpha Angle
Vs	Stall Speed - Clean
Vx	Speed that allows for best angle of climb
Vy	Speed that allows for the best rate of climb